

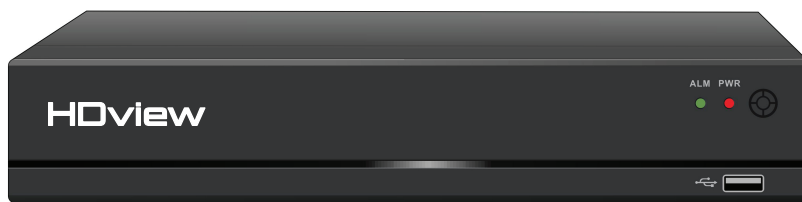

HDview

4 MEGAPIXEL CCTV SYSTEM



16K0L HD

USER MANUAL



www.espuk.com



CONTENTS

DVR Description.....	3
System Connection Diagram.....	4
System Operations.....	5
Record Setup.....	12
Menu Layout.....	17
Remote Viewing.....	18
Support Guide.....	19

This manual is designed to be used as a quick start guide alongside the informative general user interface (GUI) of the DVR. The menu above is not exhaustive and is designed to lead the user quickly to the most often required aspects of the unit.

The DVR will require a connection to a monitor to be programmed.

IMPORTANT NOTICE

- **Please read this manual** and keep for later use
- Do not use accessory devices not recommended by the manufacturer
- Please use the power adapter equipped for the unit
- Please do not touch any control parts not mentioned in the manual. Incorrect adjustment of a control part not mentioned in the manual may damage the machine
- Ensure air ventilation around the unit and do not cover or block the vent hole
- Do not place the unit in direct sunlight or near a heat source





DVR DESCRIPTION

FRONT PANEL



- 1) USB for Mouse Controller and USB backup
- 2) Power Indicator
- 3) Alarm Trigger Indicator

REAR PANEL

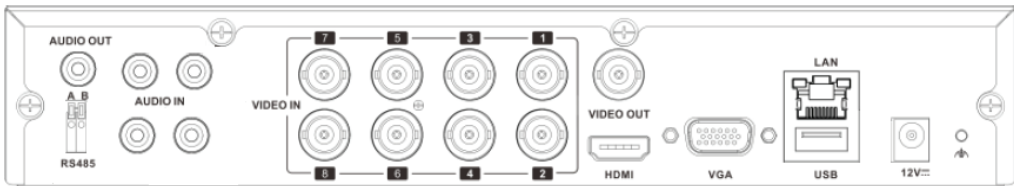

- 1) VIDEO IN 1-4/8 for Camera Video Input
- 2) HDMI Output for Monitor
- 3) Audio IN / OUT
- 4) VGA Output for Monitor
- 5) LAN Socket for Network Cable
- 6) USB for Mouse Controller and USB backup
- 7) DC12V Input Power



SYSTEM CONNECTION DIAGRAM

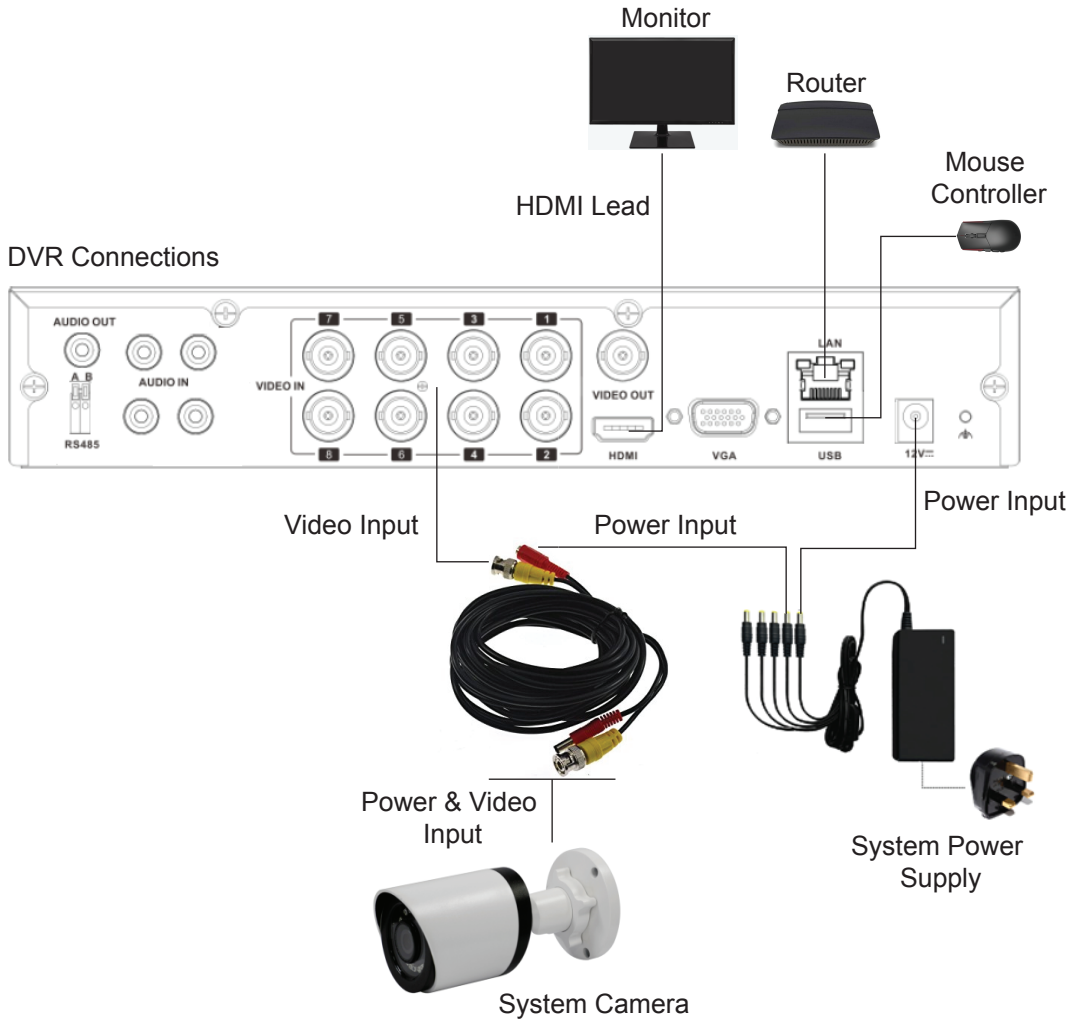

NB. The Video & Power connectors are not weatherproof. Please ensure the connections are made internally, or housed in a suitable enclosure.





SYSTEM OPERATIONS

CONNECTION TO A MONITOR

Use either HDMI or VGA output to connect to a monitor and select the correct input channel on the monitor.

CONNECTION TO A ROUTER

If remote reviewing is required from a smart-phone or PC, please connect the DVR to the router using a network cable. During power up the DVR will obtain the necessary network details.

POWER ON

Plug one lead from the 5-way power supply into the 12VDC power supply input marked on the DVR. Turn on the DVR at the mains power point. The Power supply indicator light will illuminate on the DVR's front panel followed by several short bleeps.

POWER OFF

Select Logout from the Shortcut menu and turn off the DVR at the mains power source.

N.B Auto resume after power failure. If the DVR is shut down abnormally, the DVR will automatically backup video and resume previous working status after the power is restored.

MOUSE CONTROLLER

In order to prevent un-authorized tampering majority of DVR functions of are controlled via the mouse controller.



START-UP WIZARD

The **Set-up Wizard** takes the user through basic system settings. More advanced options and settings are found in the **Main Menu**.

INTRODUCTION



LOG-IN

An opportunity to change the password is provided within the **Main Menu**. The default settings are:

User Name: admin

Password: 'leave blank, there is no default password'

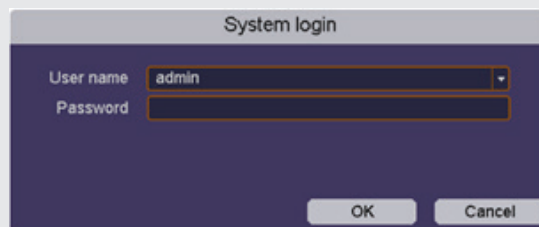



GENERAL

Set time and date:

General

Language English

Time zone [GMT+08:00]

System time 2016 - 08 - 02 17 : 44 : 13

Date separator -

Date format yyyy mm dd

Time format 24-Hour

DST Set

Auto logout 10 min

Startup wizard

Device No. 8

Host name localhost

Default Prev step Next step Exit

RECORD CONTROL

As default the system is set to record continuously on all channels on every day of the week.

The system automatically overwrites the HDD (Storage Device), so no additional recording set-up should be required.

Control

Channel 01 [D] CAM 1

Pre-Record 5 sec

Day	0	2	4	6	8	10	12	14	16	18	20	22	24
Sun	Norm.	Norm.	Norm.	Norm.	Norm.	Norm.	Norm.	Norm.	Norm.	Norm.	Norm.	Norm.	Norm.
Mon	Norm.	Norm.	Norm.	Norm.	Norm.	Norm.	Norm.	Norm.	Norm.	Norm.	Norm.	Norm.	Norm.
Tue	Norm.	Norm.	Norm.	Norm.	Norm.	Norm.	Norm.	Norm.	Norm.	Norm.	Norm.	Norm.	Norm.
Wed	Norm.	Norm.	Norm.	Norm.	Norm.	Norm.	Norm.	Norm.	Norm.	Norm.	Norm.	Norm.	Norm.
Thu	Norm.	Norm.	Norm.	Norm.	Norm.	Norm.	Norm.	Norm.	Norm.	Norm.	Norm.	Norm.	Norm.
Fri	Norm.	Norm.	Norm.	Norm.	Norm.	Norm.	Norm.	Norm.	Norm.	Norm.	Norm.	Norm.	Norm.
Sat	Norm.	Norm.	Norm.	Norm.	Norm.	Norm.	Norm.	Norm.	Norm.	Norm.	Norm.	Norm.	Norm.

Legend: Norm. (green), MD (yellow), Alarm (red)

Default Copy to Prev step Next step Exit





Hard Disk Drive (HDD) Management

This page displays the capacity of storage for the HDD. To ensure full use of the HDD please format before 1st use;

- 1) Select the HDD with the mouse control
- 2) Click **Format** and select **OK** on the prompt

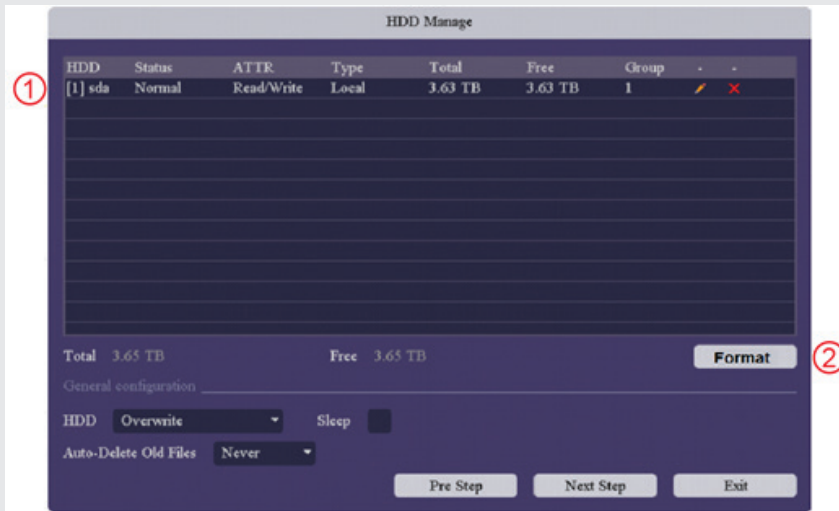



Network

The Network page displays the advanced settings for users wanting to manually enter network details.

If DHCP has been enabled the network settings will apply automatically during power up of the DVR.



CLOUD CONNECTION

The Cloud service makes remote viewing via smart phone simpler. If the status on the menu states 'Connected', scan the applicable QR to obtain the APP and ID address. For additional instruction, please refer to the supplied RekorHD 'Remote Viewing Guide'.





LIVE VIEWING

On start up the DVR will display a divided screen. Using the Mouse Control, double click on any image to bring to full screen. Double click again to return to that main divided screen.

The recording status and alarm status are indicated by the following icons:

Recording



Motion Detect



SHORTCUT MENU

Right-clicking on the live camera screen will activate the **Shortcut Menu** where the most regularly used settings can be found.

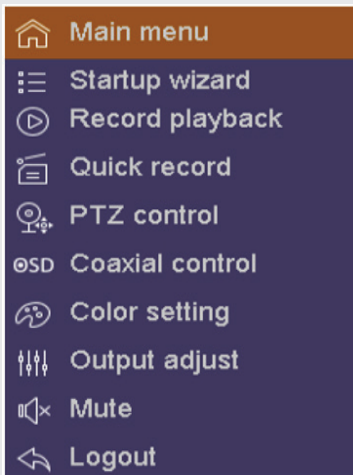

Main Menu

Enter to adjust all system settings

Start-up Wizard

Enter to adjust initial system settings

Record Playback

Shortcut for Record Control

Quick Record

To view recorded files

PTZ Control Settings

Reserved for future use

Coaxial Control

Reserved for future use

Colour Settings

Edit colour settings per channel

Output Adjust

Alter system monitor output settings

Logout

Log-out, Shutdown or Reboot system



ACCESSING THE MAIN MENU

Right click the mouse controller anywhere on screen to activate the **Shortcut Menu**.

Selecting **Main Menu** option will automatically display the following screen;

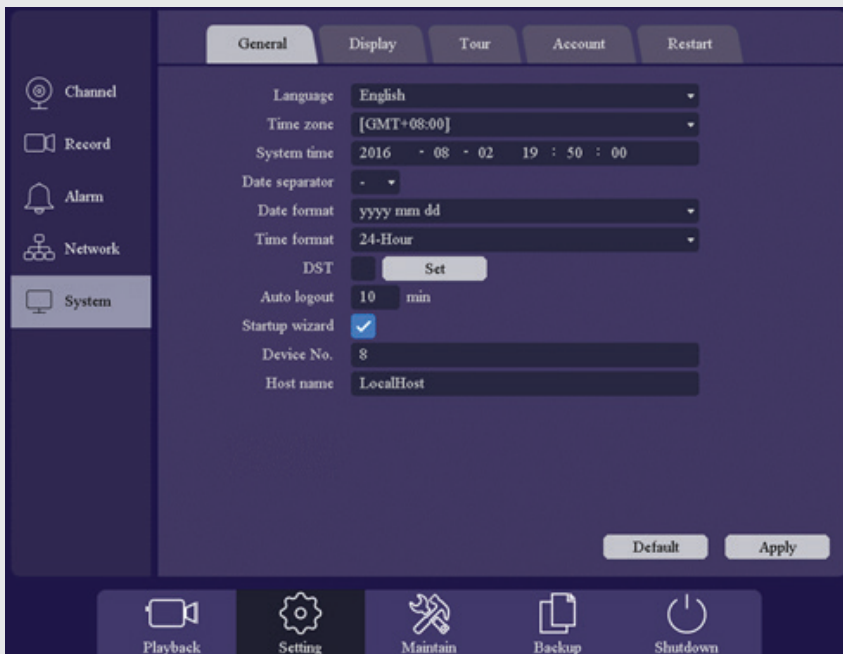

To exit from the **Main Menu** at any point Right-Click on the mouse controller.



RECORD SETUP

Continuous Record

As factory set, the unit is programmed to record all channels continuously. The HDD will overwrite once full to ensure smooth operation.

Motion Detection Record

Right-click on the live screen to bring-up the **Shortcut Menu** and selecting **Main Menu** to log-in.

From the **Setting** menu Select **Record**:



- 1) Click inside the box for **Norm.** to select the continuous record mode
- 2) Click on the eraser from Sunday to Saturday, this will remove the default continuous record function. The schedule should match the example graphic.





- 3) Select **Copy to**;



Highlight which channels are to be triggered by Motion Detection and select OK.

- 4) Returning back to the Record screen Select **Apply**
- 5) Then select **Alarm**





- 6) Select applicable channel and then select Enable
- 7) Select Trigger process

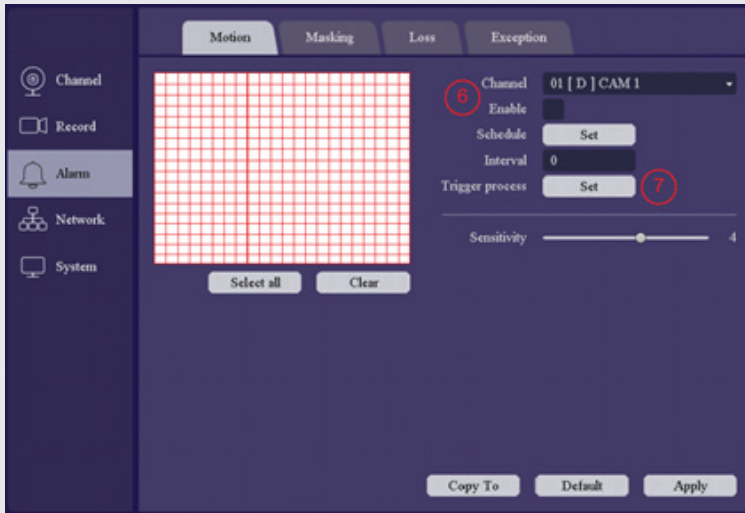

- 8) Enable **Record CHN** and highlight which channels are to record and select **Save**

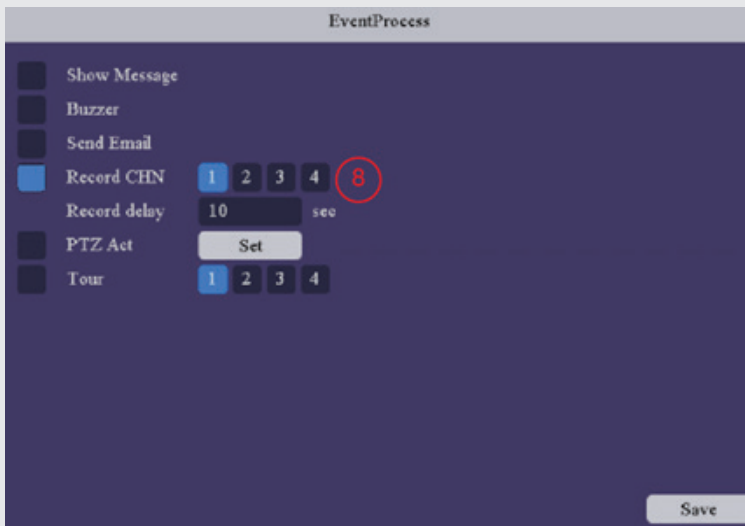



RECORD PLAYBACK

Right click on the live camera view and select **Record Playback** directly from the **Shortcut Menu**.

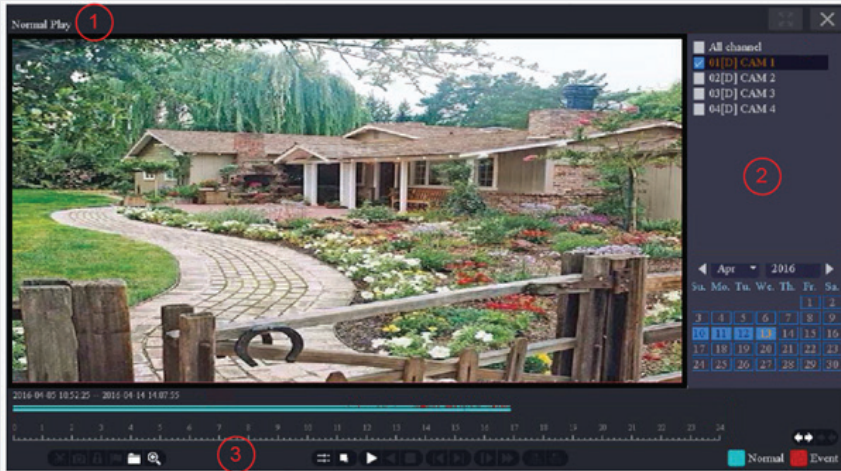

On the playback menu refer to the right hand side of the screen and enter the following;

Normal Playback Operation;

- 1) Select **Normal Play**
- 2) Select which Cameras to play back, select Month and Day from the calendar
- 3) Select play and use the cursor on the timeline to view required footage.

Event Playback Operation (Motion Detection) ;

- 1) Select **Event Play**
- 2) Select which Cameras to play back, enter Begin and End time and select Search
- 3) Double click on the required time from the list for required playback

NB. Practice playing back footage to familiarize with the process before an incident occurs.

NB. For best performance it is recommended that only one channel at a time is selected for playback.



COPY RECORDING TO USB

Insert USB stick into the DVR, Right click on the live camera view and select **Main Menu** from the **Shortcut Menu**.

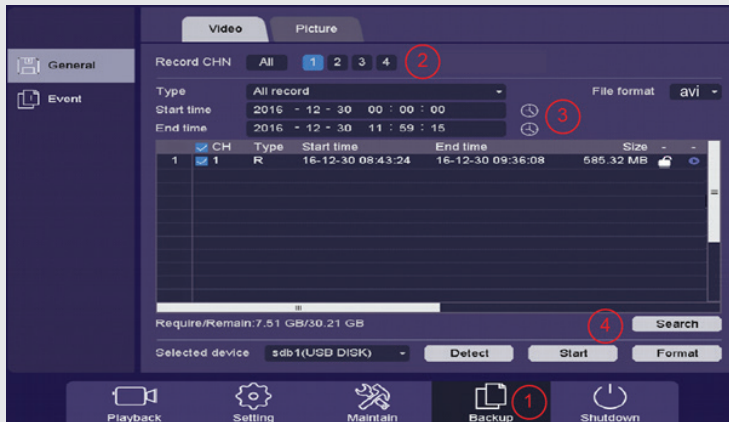

- 1) Select **Backup**
- 2) Select which **Channel** is required
- 3) Select required **Start and End Time** for the footage, also set the **File Format** to ; **AVI**
- 4) Select **Search** and the required files will be confirmed and finally select **Start** to begin backup process

NB. Practice backing-up footage to familiarize yourself with the process before an incident occurs.

NB. The AVI file will enable playback via a PC using AVI players



MENU LAYOUT

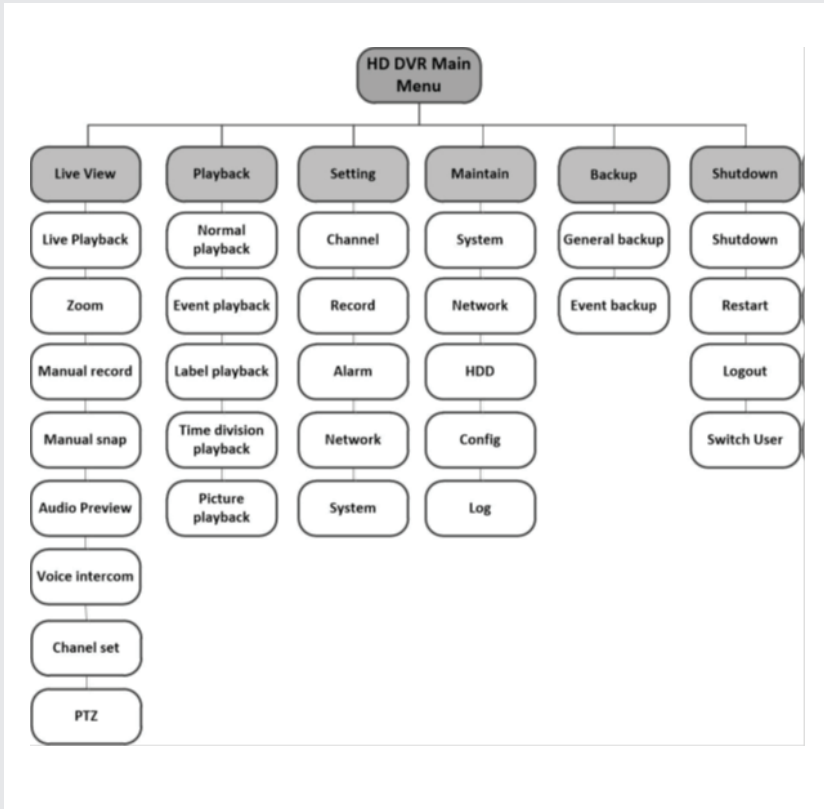



REMOTE VIEWING

Networking should always be carried out by a competent/qualified engineer, specifically when adjusting settings on the router which is sometimes required for remote viewing.

To remote view, please refer to the 'How to Remote Access your DVR' guide.

Once the DVR has been added to the network there are different methods to view the system remotely:

Smart-phone APP (IOS/Android)

PC/Laptop Software: CMS (Central Management Software) that is supplied on the CD supplied with the DVR (Windows compatible)

Web Browsing: Internet Explorer (Windows / Internet Explorer)

NB. As with all networkable devices, ESP are unable to guarantee that every device will be compatible with the DVR and software supplied. Specific models of phone, tablet or other device, the hardware it contains, the service provider, the types of data services offered and specific phone / device plan will all affect the performance of PC / mobile device for remote access to the DVR.





SUPPORT GUIDE

In the event of trouble with the system please follow the help guide.
If further problems persist please contact the installer / supplier.

The DVR will not boot up normally

- The power supply is not correctly connected/ switched On
- The incorrect power supply is being used
- The power supply is not producing the required voltage
- Disconnect any other devices connected to the power supply / DVR to identify external device trouble

Connection issue with the monitor

- The monitor cable is not correctly connected or is damaged
- The incorrect power is applied to DVR / Monitor
- The correct input channel has not been selected on the monitor
- The correct resolution has not been selected in the DVR's **GUI Display** menu
- Connect a temporary test monitor to adjust the DVR's **GUI Display** menu

There are no cameras displayed on the monitor

- The camera power supply is not correctly connected or damaged
- The camera signal cable is not correctly connected or damaged
- Try another channel input
- There is a connection issue with the monitor

I cannot find the video files in Playback mode

- Recording did not take place in the specified time range
- The recording parameters have not been programmed correctly / switched off
- Hard drive has been overwritten
- Hard drive cannot be detected

Video files not found in Playback mode

- The recording parameters have not been programmed correctly / switched off
- Hard drive has been overwritten
- Hard drive cannot be detected

DVR cannot detect hard disk

- The DVR's power supply is not correctly connected or damaged
- The HDD has not been connected correctly
- An incorrect HDD has been installed

Network connection to DVR is not stable

- Network is not stable
- DVR is not networked correctly
- Incorrect network details have been entered in the remote viewing platform



Elite Security Products
Unit 7, Target Park, Shawbank Rd
Lakeside, Redditch B98 8YN



Telephone: 01527 51 51 50
Fax: 01527 51 51 43
email: info@espuk.com

E&OE - Errors and omissions excepted. I16

www.espuk.com

